



## A new polytypic species of the genus *Uromastix* MERREM 1820 (Reptilia: Squamata: Agamidae: Leiolepidinae) from southwestern Arabia

THOMAS M. WILMS<sup>1,2,4</sup> & ANDREAS SCHMITZ<sup>3</sup>

<sup>1</sup>Reptilium - Terrarien - und Wüstenzoo, Werner-Heisenberg - Str.1, D -76289 Landau, Germany. E-mail: thomasmwilms@yahoo.de

<sup>2</sup>Zoologisches Forschungsmuseum A. Koenig, Adenauerallee 160, D-53113 Bonn, Germany.

<sup>3</sup>Muséum d'histoire naturelle, C. P. 6434 CH-1211 Genève 6, Switzerland. E-mail: andreas.schmitz@ville-ge.ch

<sup>4</sup>Corresponding author

### Abstract

We describe *Uromastix yemenensis* sp. nov. from south-western Arabia, comprising two geographic subspecies, *U. y. yemenensis* and *U. y. shobraki* ssp. nov. The new species is a member of the *Uromastix ocellata* species group, closely related to *U. benti*. It is differentiated from its sister taxon by smaller scales around midbody and smaller ventrals. The new species is restricted to the extreme south-western tip of the Arabian Peninsula. The western populations of *U. yemenensis* differ genetically and are constantly distinct in respect to their colour pattern and are therefore recognized as a subspecies.

**Key words:** Reptilia: Sauria: Agamidae: Leiolepidinae: *Uromastix yemenensis* sp. nov.; *Uromastix yemenensis shobraki* ssp. nov.; *Uromastix ocellata* species group; *Uromastix benti*; *Uromastix macfadyeni*, Yemen, Arabia

### Introduction

Spiny-tailed lizards of the genus *Uromastix* are inhabitants of the desert belt of the Old World, between 5° and 35° N. Their range covers a vast land mass, including northern Africa, Israel, Jordan, Arabia (Bahrain, Kuwait, Oman, Qatar, Saudi Arabia, United Arab Emirates, and Yemen), Iran, Iraq, Afghanistan, Pakistan, and north-western India.

According to the most recent taxonomic reviews of the entire genus *Uromastix* 16 valid species are currently accepted (Moody 1987; Wilms 2001, 2005): *Uromastix acanthinura* Bell 1825, *U. aegyptia* (Forskål 1775), *U. asmussi* (Strauch 1863), *U. alfredschmidti* Wilms & Böhme 2000a, *U. benti* (Anderson 1894), *U. dispar* von Heyden 1827, *U. geyri* L. Müller 1922, *U. hardwickii* Gray 1827, *U. loricata* (Blanford 1874), *U. leptieni* Wilms & Böhme 2000b, *U. macfadyeni* Parker 1932, *U. occidentalis* Mateo, Geniez, López-Jurado & Bons 1998, *U. ocellata* Lichtenstein 1823, *U. ornata* von Heyden 1827, *U. princeps* O'Shaughnessy 1880 and *U. thomasi* Parker 1930. Of these, the following are known to occur in Arabia: *Uromastix aegyptia*, *U. leptieni*, *U. benti*, *U. ornata* and *U. thomasi* (Wilms & Böhme, in press).

The morphology based taxonomy and phylogeny presented by Wilms (2001, 2005) has been shown to be generally in good accordance to the molecular data presented by Amer & Kumazawa (2005).

In the present paper we describe a new polytypic species, comprising two geographic subspecies, from the Republic of Yemen affiliated to the *Uromastix ocellata* species group. This species group consists of three species (*U. benti*, *U. ocellata* and *U. ornata*) inhabiting the African and Arabian littoral of the Red Sea as well as the coastal areas of the Gulf of Aden in Yemen and southern Oman. One species, *Uromastix macfadyeni*

that has, due to morphological similarities, been previously assigned to this group is most probably related to the species of the *U. acanthinura* species group (see Amer & Kumazawa 2005, as well as results given in the present paper). For a detailed review and discussion of the taxonomic history of the species of the *Uromastyx ocellata* species group and a key to the species see Wilms & Böhme (2000) and references therein.

## Material and methods

### *Morphological sampling*

152 specimens of the *Uromastyx ocellata* species group from Arabia and north-western Africa (Somalia, Djibouti, Ethiopia, Sudan, Egypt), including the type material of all taxa, have been examined. The specimens are deposited in the following collections (Institutional abbreviations in parenthesis): The Natural History Museum, London (BMNH), Naturhistorisches Museum Wien (NMW), Museo Zoologico de „La Specola“, Firenze (MZUF), Muséum d'Histoire Naturelle, Genève (MHNG), Muséum National d'Histoire Naturelle, Paris (MNHP), Museum für Tierkunde, Dresden (MTD), Naturmuseum und Forschungsinstitut Senckenberg, Frankfurt a.M. (SMF), Zoologisches Forschungsmuseum A. Koenig, Bonn (ZFMK), Zoologisches Institut und Zoologisches Museum der Universität Hamburg (ZMH), Museum für Naturkunde, Humboldt-Universität, Berlin (ZMB) and Zoologische Staatssammlung München (ZSM). For a list of examined specimens see appendix A.

For each specimen 24 external characters (16 meristic, 6 metric, 2 qualitative) have been routinely recorded: snout-vent length (SVL), length of tail (TL), head width between the anterior margins of the ear openings (HW), length from the tip of the snout to the anterior margin of the ear opening on the left side (HL), width of tail between the fourth and fifth whorl (TW), maximum tail width at the fifth whorl ( $TW_{max}$ ), number of tail whorls (W), number of scales beneath the fourth toe on the left side (SD), number of gular scales (from mental to a line between the anterior margins of the ear openings (G), number of scales around mid-body (MBS), number of scales between gular- and inguinal fold (V; ventrals), number of scales around the fifth whorl of tail (SW), number of preanofemoral pores (PP; left and right), number of enlarged scales at the anterior margin of the ear opening (LS, left and right), number of scales between suboculars and supralabials (SO, left and right), number of scales from the mid of the lower end of the ear opening to the mental scale (HS; left and right), number of scales from the upper to the lower end of the left ear opening (ES; approximately three scale rows before the anterior margin of the ear opening), number of scales from the upper end of the left ear opening to the first enlarged subocular scale (PES), presence or absence of enlarged tubercular scales at the flanks, enlarged tubercular scales at the dorsum (yes / no), intercalary scales between the tail whorls present or absent (IS). Measurements were taken to the nearest 0.5 mm using a calliper.

### *Genetic sampling*

Samples of muscle tissue were sampled from fresh specimens as well as from preserved specimens kept in the collection of the ZFMK, Bonn. All new voucher specimens are now also kept in the herpetological collection of the ZFMK (for a complete list of voucher specimens see Table 1).

DNA was extracted from the tissue samples using QuiAmp tissue extraction kits (Quiagen) or a modified Chelex-Protocol (Walsh et al. 1991; Schmitz 2003). The primers 16sar-L (light chain; 5' - CGC CTG TTT ATC AAA AAC AT - 3') and 16sbr-H (heavy chain; 5' - CCG GTC TGA ACT CAG ATC ACG T - 3') of Palumbi et al. (1991) were used to amplify a section of the mitochondrial 16S ribosomal RNA gene. PCR cycling procedure was as follows; an initial denaturation step of 90 s at 94°C followed by 33 cycles of denaturation for 45 s at 94°C, primer annealing for 45 s at 55°C and extension for 90 s at 72°C. PCR products were purified using Qiaquick purification kits (Qiagen). Sequences (including complimentary strands for assuring the accuracy of the sequences) were obtained using an automatic sequencer (ABI 377). Sequences were

aligned using ClustalX (Thompson et al., 1997; default parameters) and manually checked using the original chromatograph data in the program BioEdit (Hall 1999). We performed maximum parsimony (MP) and Bayesian reconstructions. We used PAUP\* 4.0b10 (Swofford 2002) to compute the maximum parsimony tree and the uncorrected pairwise distances for all sequences. For the Bayesian analysis parameters of the model were estimated from the data set using MrModeltest 1.1b (Nylander 2002) and the analyses were performed with MrBayes, version 3.0b4 (Huelsenbeck & Ronquist 2001). The comparison between the different likelihood scores for each model showed the GTR +  $\Gamma$  model (Yang et al. 1994) to be the optimal model for the data set.

**TABLE 1.** List of samples used for genetic analysis (geographic origin, locality and GenBank accession numbers).

Species	Geographic origin	Locality	Voucher	Accession number
<i>U. ocellata</i>	Sudan	unknown	ZFMK 83798	EF081044
<i>U. ocellata</i>	Sudan	unknown	ZFMK 83799	EF081045
<i>U. o. ornata</i>	Egypt	Sinai Peninsula	ZFMK 83808	EF081047
<i>U. o. ornata</i>	Egypt	Sinai Peninsula	ZFMK 83809	EF081048
<i>U. o. ornata</i>	Egypt	Sinai Peninsula	ZFMK 83810	EF081049
<i>U. o. ornata</i>	Egypt	Sinai Peninsula	ZFMK 83812	EF081052
<i>U. o. ornata</i>	Egypt	Sinai Peninsula	ZFMK 83813	EF081053
<i>U. o. ornata</i>	Egypt	Sinai Peninsula	ZFMK 83814	EF081050
<i>U. o. ornata</i>	Egypt	Sinai Peninsula	ZFMK 83815	EF081051
<i>U. o. philbyi</i>	Saudi Arabia	19°05'N 41°50'E	ZFMK 84442	EF081046
<i>U. y. shobraki</i>	Yemen	Mafraq-Mocca	ZFMK 48680, Paratype	EF081072
<i>U. y. shobraki</i>	Yemen	Mafraq-Mocca	ZFMK 48681, Holotype	EF081067
<i>U. y. shobraki</i>	Yemen	Northwest Yemen	ZFMK 55651	EF081073
<i>U. y. shobraki</i>	Yemen	Northwest Yemen	ZFMK 55652	EF081071
<i>U. y. shobraki</i>	Yemen	Northwest Yemen	ZFMK 58047	EF081069
<i>U. y. shobraki</i>	Yemen	Northwest Yemen	ZFMK 66687	EF081070
<i>U. y. shobraki</i>	Yemen	Northwest Yemen	ZFMK 73675	EF081068
<i>U. y. shobraki</i>	Yemen	Northwest Yemen	ZFMK 73676	EF081066
<i>U. y. shobraki</i>	Yemen	Northwest Yemen	ZFMK 73677	EF081065
<i>U. y. shobraki</i>	Yemen	Northwest Yemen	ZFMK 73678	EF081074
<i>U. y. shobraki</i>	Yemen	Northwest Yemen	ZFMK 85162	EF081064
<i>U. y. yemenensis</i>	Yemen	Vicinity of Lodar	ZFMK 47860, Paratype	EF081063
<i>U. y. yemenensis</i>	Yemen	Vicinity of Lodar	ZFMK 47861, Holotype	EF081058
<i>U. y. yemenensis</i>	Yemen	Vicinity of Lodar	ZFMK 49036, Paratype	EF081062
<i>U. y. yemenensis</i>	Yemen	unknown	ZFMK 83805	EF081059
<i>U. y. yemenensis</i>	Yemen	unknown	ZFMK 83806	EF081060
<i>U. y. yemenensis</i>	Yemen	unknown	ZFMK 83807	EF081061
<i>U. benti</i>	Oman, Dhofar	Vicinity of Mirbat	ZFMK 73680	EF081057
<i>U. benti</i>	Oman, Dhofar	Vicinity of Mirbat	ZFMK 73681	EF081055
<i>U. benti</i>	Oman, Dhofar	Vicinity of Mirbat	ZFMK 83347	EF081056
<i>U. benti</i>	Oman, Dhofar	Vicinity of Mirbat	ZFMK 83801	EF081054
<i>U. macfadyeni</i>	Somalia	unknown	ZFMK 84440	EF081043
<i>U. macfadyeni</i>	Somalia	unknown	ZFMK 84441	EF081042

Thirty-four 16S sequences comprising 529 bp (lengths referring to the aligned sequences including gaps) were obtained. *Tympanocryptis tetraporophora* (Agamidae: Agaminae) was used as outgroup. For the MP analysis, we used the “heuristic search” with the “random addition” option of PAUP\* (Swofford 2002) with 10 replicates, using the TBR (tree bisection-reconnection) branch swapping option. Additionally, we used bootstrap analyses with 2000 pseudoreplicates to evaluate the relative branch support in the phylogenetic analysis. For the Bayesian analyses we ran two MCMC analyses for  $10^6$  generations each. The initial 100000 (10%) trees were disregarded as “burn-in”. We consider probabilities of 95% or greater to be significantly supported. The exact parameters used for the Bayesian analyses followed those described in detail by Reeder (2003). Sequences have been submitted to GenBank; for accession numbers see Tab. 1.

#### *Statistical analyses of morphological data*

The Excel 2000, SPSS (10.0) and R 2.2.1 (R Development Core Team 2005) statistical packages were used to run the analyses. Hierarchical Cluster analysis and Principal Component Analysis (PCA) have been selected to evaluate the morphological data and to explore the relationships between the taxa examined. Statistical significance of characters between the respective taxa has been tested using Mann-Whitney U test.

#### *Hierarchical cluster analysis*

Cluster analysis is a common technique for statistical data analysis. Hierarchical cluster analysis is comprised of agglomerative methods and divisive methods that find clusters of observations within a data set. The divisive methods start with all of the observations in one cluster and then proceeds to split (partition) them into smaller clusters. The agglomerative methods begin with each observation being considered as separate clusters and then proceeds to combine them until all observations belong to one cluster. Because of the many different methods to calculate distances in a given matrix and the large number of clustering algorithms this method is much more subjective than the ordination techniques such as PCA (Jardine & Sibson 1968; Rastegar-Pouyani 2005). In the present study the use of average linkage method has produced the highest cophenetic correlation coefficients and the highest  $\gamma$ -coefficients. Both coefficients provide a measure for the reliability of an cluster analysis and according to Handl (2002) a  $\gamma$ -coefficient larger than 0.700 indicates, that the fit of the analysis is satisfactory or better. A cophenetic correlation coefficient above 0.750 is considered good fit (Rastegar-Pouyani 2005).

#### *Principal component analysis (PCA)*

Principal Component Analysis (PCA) is a multivariate procedure which rotates the data such that maximum variabilities are projected onto the axes. Essentially, a set of correlated variables are transformed into a set of uncorrelated variables which are ordered by reducing variability. The uncorrelated variables are linear combinations of the original variables, and the last of these variables can be removed with minimum loss of real data. The main use of PCA is to reduce the dimensionality of a data set while retaining as much information as is possible. Results of PCAs do not depend on a priori specimen classification.

## **Results and discussion**

#### *Multivariate analyses of the taxa of the Uromastix ocellata species group*

A distance phenogram based on four meristic characters of 112 individual specimens from the *Uromastix ocellata* species group (66 males, 28 females, 15 juveniles, 3 unknown; variables see Table 2) was calculated using the average linkage method (Fig. 1). The cophenetic correlation coefficient is 0.854, while the  $\gamma$ -coefficient is 0.785. Both coefficients imply a high degree of significance. The resulting distance phaenogram shows four distinct clusters, of which one is including all specimens of *U. ornata* as well as the three *U. mac-*

*fadyeni* included in the present study. The second cluster included all *U. ocellata* and the third and fourth cluster all individuals previously assigned to *U. benti*. Within the two clusters containing *U. benti* sensu lato, a strong geographic correlation was evident. One cluster almost exclusively contained specimens from the western and southern parts of Yemen (only one specimen, BMNH 1946.8.11.68, Paralectotype of *U. benti*, is from southeastern Yemen; Makulla, Hadramaut), while the second cluster contained, with four exceptions (BMNH 99.12.13.106, BMNH 1938.2.1.47, MTD 25441, ZFMK 58047), specimens from southeastern Yemen and the Sultanate of Oman. Because of these findings the existence of a second, hitherto unknown taxon was postulated and a principal component analysis (PCA) was applied on data obtained from individuals of these two clusters [referred to as OTU1 (specimens from southeastern Yemen and Oman) and OTU2 (specimens from western and southern Yemen)].

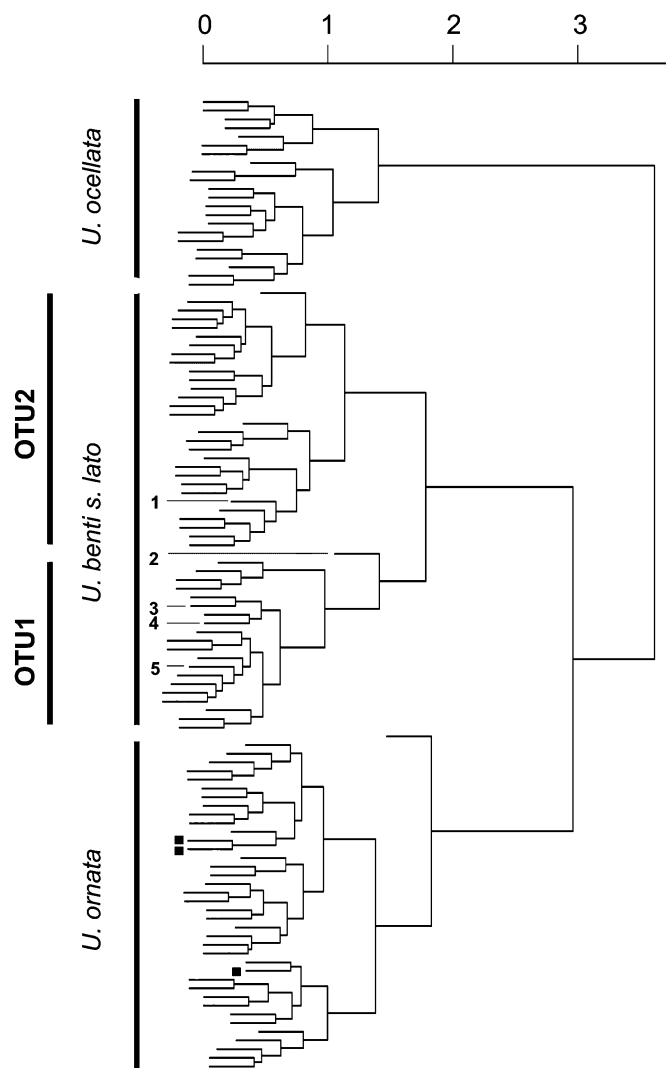

**FIGURE 1.** Distance phenogram based on 112 individuals from the *Uromastyx ocellata* species group (Variables: V9, V10, V17, V18; hierarchical cluster using average linkage). OTU1 including specimens from southeastern Yemen and Oman (exceptions; 2: BMNH 99.12.13.106, 3: ZFMK 58047, 4: MTD 25441, 5: BMNH 1938.2.1.47) and OTU2 including specimens from western and southern Yemen (exception; 1: BMNH 1946.8.11.68, Paralectotype *U. benti*). Squares indicate the position of the three specimens of *U. macfadyeni* included in this study.

We run a principal component analysis using the variables V1-V16 for the same individuals of OTU1 and OTU2, excluding MTD 31624 (doubtful locality data) and adding six new specimens (for variables see Table 3). The factor loadings of the first three principal components are listed in Table 4. In the projection of the first

two principal components the southeastern Yemeni and Omani specimens (OTU1) group together according to the a priori specimen classification, as well as the western and southern Yemeni specimens respectively (both together OTU2). There is no overlapping between both OTUs. Within OTU2 two clusters can be identified correlating with a western respectively southern origin of the specimens involved (Fig. 2). To clarify this situation, a molecular approach was chosen.

**TABLE 2.** Variables used to calculate a distance phenogram (hierarchical cluster using average linkage method).

Variable	V9	V10	V17	V18
Definition	MBS	V	PP left	PP right

**TABLE 3.** Definition of variables used for the PCA.

Variable	V1	V2	V3	V4	V5	V6	V7	V8
Definition	SVL +TL	SVL*100/TL	HW/HL	W	SD	TWmax-TW/2	TL/TWmax	G
Variable	V9	V10	V11	V12	V13	V14	V15	V16
Definition	MBS	V	SW	LS left	LS right	SO left	SO right	ES * PES

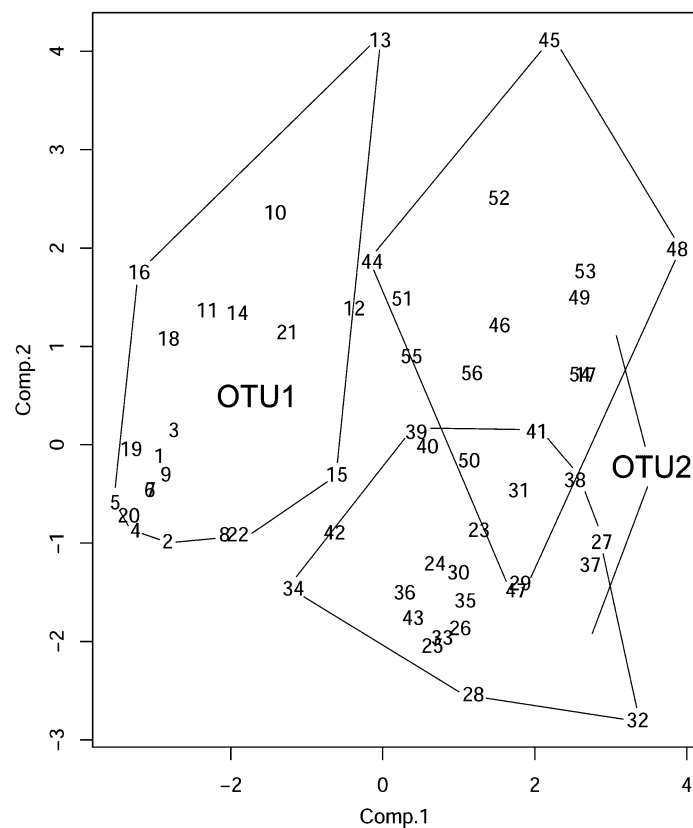

**FIGURE 2.** Projection of the first two principal components from a PCA run on 56 individuals assignable to OTU1 and OTU2 (50 specimens already used with the hierarchical cluster analysis plus six additional individuals).

#### *Molecular analyses of the taxa of the Uromastix ocellata species group*

Of the 529 characters from the 16S rRNA gene 94 were parsimony-informative. The matrix for the uncorrected p-distances for all nucleotide sites is presented in Tab. 5.

Both analysis methods recovered the same supported tree topology. The heuristic search of the MP analy-

sis produced 2 most-parsimonious trees (tree length = 157; not shown). The tree from the Bayesian analysis is shown in Fig. 3. The statistically supported nodes are identical in both MP and Bayes analyses. Therefore, we have plotted the supporting values of both the bootstraps and the posterior probabilities on the same pictured tree (Fig. 3).

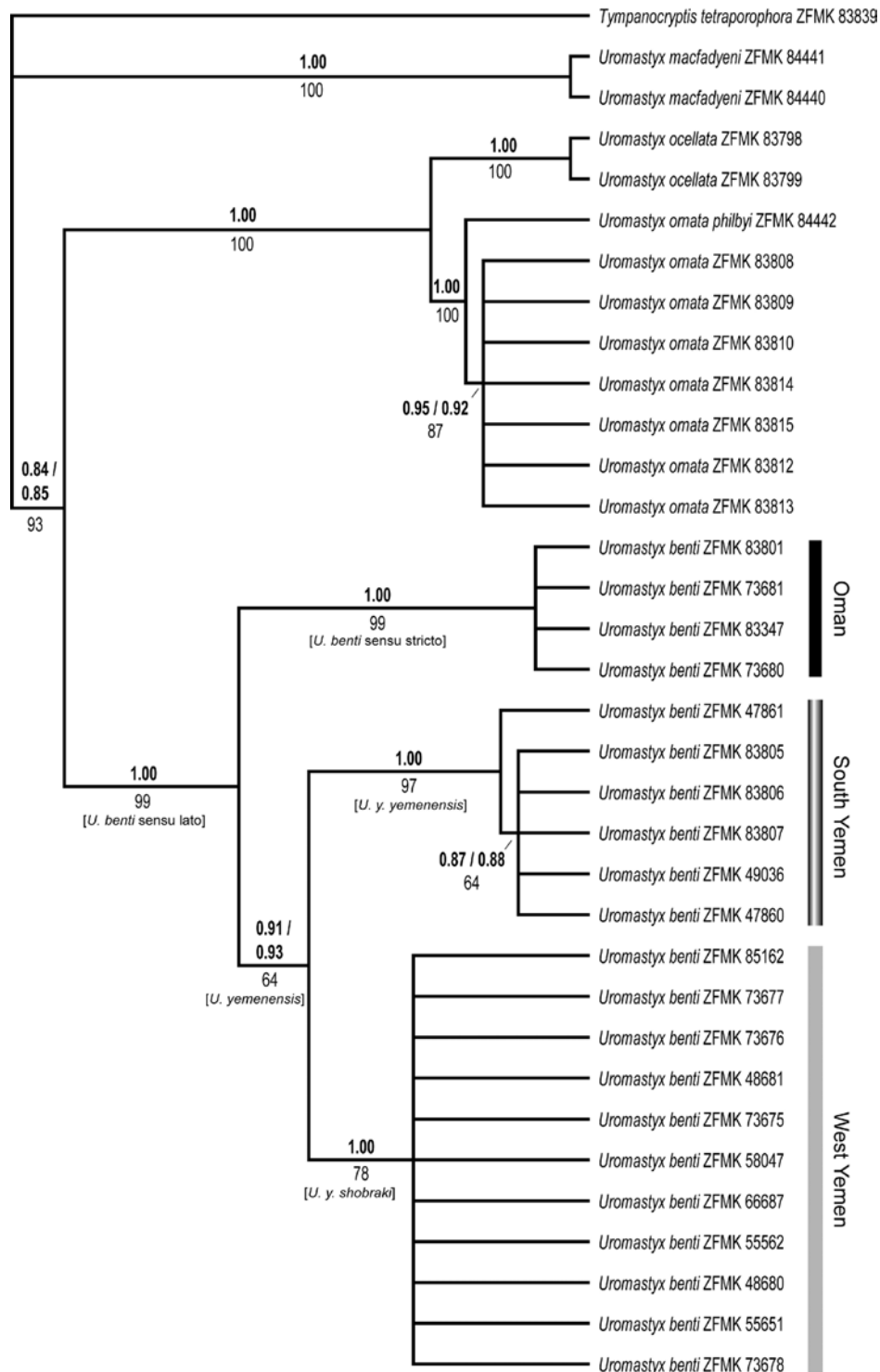

**FIGURE 3.** Cladogram of the tree recovered by the Bayes analyses based on 529 bp of the mitochondrial 16S ribosomal RNA gene sequences. Upper (bold) values at the nodes are Bayesian posterior probabilities (values below 0.5 not shown); lower values are maximum-parsimony bootstrap replicates (2000 replicates with 100 random additions; values below 50 % not shown). The new taxon denominations are indicated in squared brackets.

The two included samples of *Uromastix macfadyeni* form a strongly supported clade basal to and clearly outside the rest of the species (PP: 1.00/MP: 100). The remaining ingroup specimens constitute a large clade (MP: 93) which is itself subdivided: one component clade comprises the species *U. ornata* (including the specimen of the subspecies *U. o. philbyi*) and *U. ocellata* (PP: 1.00/MP: 100). Both of the nominal species are clearly separate species-units (PP: 1.00/MP: 100).

The second component clade includes all specimens of *Uromastix benti* sensu lato (PP: 1.00/MP: 99). In this clade we find a well supported substructure, consisting of three subclades, each of which comprises the specimens of a special zoogeographic region. The basal-most subclade consists of the sampled specimens from the Sultanate of Oman (PP: 1.00/MP: 99), corresponding to OTU1 from the morphological analysis. The other two subgroups (OTU2 from the morphology) are sister groups (PP: 0.93/MP: 64) and both of them form highly significantly supported clades, each again with the specimens from a specific zoogeographical region (South Yemen — PP: 1.00/MP: 97; West Yemen — PP: 1.00/MP: 78). These three subclades while each showing a very low internal genetic variation within each clade (West Yemen: 0.0%–0.3%; South Yemen: 0.0%–0.6%; Oman: 0.0%–0.4%), are quite widely separated from each other. Genetic distances are as follows: Oman-South Yemen: 2.7%–3.3%; Oman-West Yemen 2.3%–2.9%; South Yemen-West Yemen: 1.9%–2.3% (Tab. 5).

#### *Synthesis and discussion of the results obtained from multivariate and genetic analyses*

The results of the hierarchical cluster analysis of morphology show, that phenetically four clusters are distinguishable within the *Uromastix ocellata* species group (Fig. 1). One cluster each, containing all specimens of *U. ocellata* and *U. ornata* respectively and two clusters containing the specimens previously identified as *U. benti*. This same pattern is also recovered by the molecular analyses, and the respective nodes are strongly supported (Fig. 3). One species that has been traditionally treated as a member of this group (*U. macfadyeni*) grouped within the *U. ornata* cluster. But this is likely to be due to a convergent evolution as Amer & Kumazawa (2005) found, that *U. macfadyeni* clustered with North African taxa (*U. acanthinura*, *U. dispar*, *U. geyri*) in a molecular study using data obtained from complete nucleotide sequences for the mtDNA between the tRNA<sup>Glutamine</sup> and tRNA<sup>Tyrosine</sup> (approx. 1.7 kbp). This is again in accordance with our results based on data obtained from the 16S rRNA, which show clearly that the genetic distance of *U. macfadyeni* from the other species of the ingroup is very high (9.4%–12.3%) (Fig. 3; Tab. 5).

Within *Uromastix benti* there was a strong geographic correlation (southeast Yemen and Oman cluster (OTU1) versus west and south Yemen cluster (OTU2)) with only five specimens out of 51 not placed in accordance with their geographic origin. One of these 51 specimens [MTD 31624; with doubtful locality (pet trade)] was eliminated from further analysis and data of six specimens were added to carry out a PCA based on 16 variables. The plot of the first two principal components shows three clusters (OTU 1 and OTU 2: two overlapping clusters). With the exception of two specimens (BMNH 1946.8.11.68, Lectoparatype of *U. benti*; MTD 25441, Amran, ‘Tiefeland vor Aden’, southern Yemen) all animals clustered in accordance with their geographical origin. Specimen BMNH 1946.8.11.68 differs from Oman and other south-eastern Yemen specimens in its meristic and metric characters, and in its coloration and pattern as well. Therefore we suggest that BMNH 1946.8.11.68 does not belong to *U. benti* but to the herein described species. Anderson (1894) mentioned six specimens of *U. benti* in his description of this species, all collected “near Makulla, below the plateau” by “his collector”. We think that it is not impossible, that at least some of these specimens have been purchased from local people who may have collected more widely and therefore we do not recognize this as an evidence of sympatry of both taxa. Because BMNH 1946.8.11.72, rather than BMNH 1946.8.11.68, was designated as the lectotype of *U. benti* out of the series of six syntypes (BMNH 1946.8.11.68–72, MHNP 1895.43; Wilms & Böhme 2000) this new finding has no taxonomic consequences. The second anomalous specimen (MTD 25441) from Amran, Lowlands in the vicinity of Aden, southern Yemen, can be assigned without any doubt to *U. benti*, on the basis of meristic and metric characters and coloration and pattern.



Because of the relatively imprecise locality given, and the fact, that this specimen has been kept in captivity for some time, we suggest, that its locality data are incorrect.

Of the remaining three specimens (BMNH 99.12.13.106, BMNH 1938.2.1.47, ZFMK 58047) that had not clustered according to their geographic origin in the hierarchical cluster analysis two clustered perfectly into OTU2 (BMNH 99.12.13.106, North of Lahej, S. Arabia; ZFMK 58047, North Yemen). The remaining specimen (BMNH 1938.2.1.47) has the locality data “Southern Hejaz, Arabia”. As Arnold (1986) pointed out, the collector of this specimen, H. StJ. B. Philby, used “Southern Hejaz” in an extremely liberal way and some of his material is actually coming from as far south as Shabwa (15°22’N 47°00’E) in southern Yemen. In the PCA this specimen clustered within the northern Yemen fraction of OTU2. We therefore believe that this specimen is in fact from the Southern Hejaz (south-western Saudi Arabia) or from north-western Yemen.

The main difference between the specimens in OTU1 and OTU2 is in the number of scales around mid-body and in the number of ventral scales (for details see Table 6).

**TABLE 4.** Factor loading on the first three principal components from a correlation matrix of V1–V16 for individuals of OTU1 and OTU2.

Variable	Comp. 1	Comp. 2	Comp.3
V1		- 0.208	- 0.509
V2	0.266	- 0.186	0.129
V3		- 0.421	0.155
V4	0.350		0.165
V5	0.286	- 0.304	- 0.151
V6		- 0.111	- 0.605
V7	0.300		0.314
V8	0.290		
V9	0.372		- 0.226
V10	0.397	- 0.145	- 0.136
V11	0.227		- 0.167
V12	- 0.158	- 0.294	0.178
V13	- 0.144	- 0.204	0.188
V14		0.513	- 0.114
V15		0.455	
V16	0.371		
Eigenvalues	4.428	2.286	1.925
Accumulated percent of trace	28.18	42.72	54.97

Based on the results of the exploring statistics it is evident, that OTU1 is taxonomically distinct from OTU2. The lectotype of *U. benti*, as well as the syntypes of *U. simonyi* Steindachner 1899, are clustering within OTU1. Therefore the specimens from south-eastern Yemen and Oman have to be assigned to *U. benti*. With the exception of *U. simonyi*, which is a junior synonym of *U. benti*, no other name is available for the specimens within the OTUs in question. These morphological data are in complete accordance with our genetic analyses, which also recovered the two mentioned OTUs and showed that there is a considerable genetic distance between them. The discovery, that there is also a substantial genetic distance between the two groups of OTU2 may well indicate that the West Yemen populations also constitute a different species than the animals from the South Yemen populations (especially, since they are only slightly lower than the genetic

TABLE 5. Summary of the uncorrected p-distances for the 16S data set.

Taxon	1	2	3	4	5	6	7	8	9	10	11	12	13	14	15	16
1 <i>Tympanocryptis tetrapophora</i> ZFMK 83839	-															
2 <i>Uromastix macfadyeni</i> ZFMK 84441	0.197	-														
3 <i>Uromastix macfadyeni</i> ZFMK 84440	0.197	0.000	-													
4 <i>Uromastix ocellata</i> ZFMK 83798	0.203	0.121	0.121	-												
5 <i>Uromastix ocellata</i> ZFMK 83799	0.205	0.123	0.123	0.002	-											
6 <i>Uromastix ornata philbyi</i> ZFMK 84442	0.207	0.117	0.117	0.054	0.056	-										
7 <i>Uromastix ornata</i> ZFMK 83808	0.209	0.113	0.113	0.050	0.052	0.010	-									
8 <i>Uromastix ornata</i> ZFMK 83809	0.211	0.115	0.115	0.052	0.054	0.012	0.002	-								
9 <i>Uromastix ornata</i> ZFMK 83810	0.211	0.116	0.116	0.052	0.054	0.012	0.002	0.004	-							
10 <i>Uromastix ornata</i> ZFMK 83814	0.209	0.113	0.113	0.050	0.052	0.010	0.000	0.002	0.002	-						
11 <i>Uromastix ornata</i> ZFMK 83815	0.209	0.113	0.113	0.050	0.052	0.010	0.000	0.002	0.002	0.000	-					
12 <i>Uromastix ornata</i> ZFMK 83812	0.209	0.113	0.113	0.050	0.052	0.011	0.002	0.004	0.004	0.002	0.002	-				
13 <i>Uromastix ornata</i> ZFMK 83813	0.209	0.113	0.113	0.050	0.052	0.010	0.000	0.002	0.002	0.000	0.000	0.002	-			
14 <i>Uromastix bentii</i> ZFMK 83801	0.193	0.094	0.094	0.077	0.079	0.069	0.066	0.068	0.068	0.066	0.066	0.068	0.066	-		
15 <i>Uromastix bentii</i> ZFMK 73681	0.197	0.098	0.098	0.081	0.083	0.073	0.069	0.071	0.072	0.069	0.069	0.071	0.069	0.004	-	
16 <i>Uromastix bentii</i> ZFMK 83347	0.193	0.094	0.094	0.077	0.079	0.069	0.066	0.068	0.068	0.066	0.066	0.068	0.066	0.000	0.004	-
17 <i>Uromastix bentii</i> ZFMK 73680	0.193	0.094	0.094	0.077	0.079	0.069	0.066	0.068	0.068	0.066	0.066	0.068	0.066	0.000	0.004	0.000
18 <i>Uromastix bentii</i> ZFMK 47861	0.202	0.099	0.099	0.079	0.081	0.064	0.068	0.070	0.071	0.068	0.068	0.070	0.068	0.027	0.031	0.027
19 <i>Uromastix bentii</i> ZFMK 83804	0.201	0.096	0.096	0.081	0.083	0.066	0.070	0.072	0.072	0.070	0.070	0.071	0.070	0.029	0.033	0.029
20 <i>Uromastix bentii</i> ZFMK 83806	0.202	0.097	0.097	0.081	0.083	0.066	0.070	0.072	0.072	0.070	0.070	0.072	0.070	0.029	0.033	0.029
21 <i>Uromastix bentii</i> ZFMK 83807	0.201	0.096	0.096	0.081	0.083	0.066	0.070	0.072	0.072	0.070	0.070	0.071	0.070	0.029	0.033	0.029
22 <i>Uromastix bentii</i> ZFMK 49036	0.231	0.110	0.110	0.078	0.078	0.058	0.064	0.064	0.065	0.064	0.064	0.066	0.064	0.031	0.036	0.031
23 <i>Uromastix bentii</i> ZFMK 47860	0.211	0.100	0.100	0.083	0.086	0.067	0.071	0.073	0.074	0.071	0.071	0.074	0.071	0.031	0.035	0.031
24 <i>Uromastix bentii</i> ZFMK 85162	0.195	0.096	0.096	0.077	0.079	0.069	0.070	0.071	0.072	0.070	0.070	0.071	0.070	0.023	0.027	0.023
25 <i>Uromastix bentii</i> ZFMK 73677	0.197	0.098	0.098	0.079	0.081	0.071	0.071	0.073	0.074	0.071	0.071	0.073	0.071	0.025	0.029	0.025
26 <i>Uromastix bentii</i> ZFMK 73676	0.195	0.096	0.096	0.077	0.079	0.069	0.070	0.071	0.072	0.070	0.070	0.071	0.070	0.023	0.027	0.023
27 <i>Uromastix bentii</i> ZFMK 48681	0.195	0.096	0.096	0.077	0.079	0.069	0.070	0.071	0.072	0.070	0.070	0.071	0.070	0.023	0.027	0.023
28 <i>Uromastix bentii</i> ZFMK 73675	0.195	0.096	0.096	0.077	0.079	0.069	0.070	0.071	0.072	0.070	0.070	0.071	0.070	0.023	0.027	0.023
29 <i>Uromastix bentii</i> ZFMK 58047	0.195	0.096	0.096	0.077	0.079	0.069	0.070	0.071	0.072	0.070	0.070	0.071	0.070	0.023	0.027	0.023
30 <i>Uromastix bentii</i> ZFMK 66687	0.195	0.096	0.096	0.077	0.079	0.069	0.070	0.071	0.072	0.070	0.070	0.071	0.070	0.023	0.027	0.023
31 <i>Uromastix bentii</i> ZFMK 55562	0.195	0.096	0.096	0.077	0.079	0.069	0.070	0.071	0.072	0.070	0.070	0.071	0.070	0.023	0.027	0.023
32 <i>Uromastix bentii</i> ZFMK 48680	0.218	0.113	0.113	0.079	0.079	0.067	0.067	0.067	0.067	0.067	0.067	0.070	0.067	0.024	0.024	0.024
33 <i>Uromastix bentii</i> ZFMK 55651	0.195	0.096	0.096	0.077	0.079	0.069	0.070	0.071	0.072	0.070	0.070	0.071	0.070	0.023	0.027	0.023
34 <i>Uromastix bentii</i> ZFMK 73678	0.195	0.096	0.096	0.077	0.079	0.069	0.070	0.071	0.072	0.070	0.070	0.071	0.070	0.023	0.027	0.023

TABLE 5 (continued).

Taxon	19	20	21	22	23	24	25	26	27	28	29	30	31	32	33	34
1 <i>Tympanocryptis tetraporophora</i> ZFMK 83839																
2 <i>Uromastix macfadanyi</i> ZFMK 84441																
3 <i>Uromastix macfadanyi</i> ZFMK 84440																
4 <i>Uromastix ocellata</i> ZFMK 83798																
5 <i>Uromastix ocellata</i> ZFMK 83799																
6 <i>Uromastix ornata philbyi</i> ZFMK 84442																
7 <i>Uromastix ornata</i> ZFMK 83808																
8 <i>Uromastix ornata</i> ZFMK 83809																
9 <i>Uromastix ornata</i> ZFMK 83810																
10 <i>Uromastix ornata</i> ZFMK 83814																
11 <i>Uromastix ornata</i> ZFMK 83815																
12 <i>Uromastix ornata</i> ZFMK 83812																
13 <i>Uromastix ornata</i> ZFMK 83813																
14 <i>Uromastix bentii</i> ZFMK 83801																
15 <i>Uromastix bentii</i> ZFMK 73681																
16 <i>Uromastix bentii</i> ZFMK 83347																
17 <i>Uromastix bentii</i> ZFMK 73680																
18 <i>Uromastix bentii</i> ZFMK 47861																
19 <i>Uromastix bentii</i> ZFMK 83804																
20 <i>Uromastix bentii</i> ZFMK 83806	0.000	-														
21 <i>Uromastix bentii</i> ZFMK 83807	0.000	0.000	-													
22 <i>Uromastix bentii</i> ZFMK 49036	0.000	0.000	0.000	-												
23 <i>Uromastix bentii</i> ZFMK 47860	0.002	0.002	0.002	0.000	-											
24 <i>Uromastix bentii</i> ZFMK 85162	0.021	0.021	0.021	0.021	0.023	-										
25 <i>Uromastix bentii</i> ZFMK 73677	0.023	0.021	0.023	0.023	0.025	0.002	-									
26 <i>Uromastix bentii</i> ZFMK 73676	0.021	0.021	0.021	0.021	0.023	0.000	0.002	-								
27 <i>Uromastix bentii</i> ZFMK 48681	0.021	0.021	0.021	0.021	0.023	0.000	0.002	0.000	-							
28 <i>Uromastix bentii</i> ZFMK 73675	0.021	0.021	0.021	0.021	0.023	0.000	0.002	0.000	0.000	-						
29 <i>Uromastix bentii</i> ZFMK 58047	0.021	0.021	0.021	0.021	0.023	0.000	0.002	0.000	0.000	0.000	-					
30 <i>Uromastix bentii</i> ZFMK 66687	0.021	0.021	0.021	0.021	0.023	0.000	0.002	0.000	0.000	0.000	0.000	-				
31 <i>Uromastix bentii</i> ZFMK 55562	0.021	0.021	0.021	0.021	0.023	0.000	0.002	0.000	0.000	0.000	0.000	0.000	-			
32 <i>Uromastix bentii</i> ZFMK 48680	0.027	0.027	0.027	0.023	0.024	0.003	0.003	0.003	0.003	0.003	0.003	0.003	0.003	-		
33 <i>Uromastix bentii</i> ZFMK 55651	0.021	0.021	0.021	0.021	0.023	0.000	0.002	0.000	0.000	0.000	0.000	0.000	0.000	0.003	-	
34 <i>Uromastix bentii</i> ZFMK 73678	0.021	0.021	0.021	0.021	0.023	0.000	0.002	0.000	0.000	0.000	0.000	0.000	0.000	0.003	0.000	-

distance between the two principal OTUs). From a morphological point of view the differences in the analysed meristic and metric characters between the West and South Yemen populations are not significant, but the respective specimens are easily recognizable on the basis of constant differences in colouration and pattern. Because of these morphological findings we consider both taxa to be conspecific forming a polytypic species with two geographic subspecies.

**TABLE 6.** Mean of scales around midbody (MBS) and ventral scales (V) of the specimens from OTU1 and OTU2 (standard deviation in parenthesis). The differences between OTU1 and OTU2 are for both characters highly significant (level of significance 99%,  $P < 0.001$ ).

	OTU1	OTU2	Mann-Whitney U test
MBS	160,05 (8,98)	192,53 (16,63)	$P < 0.001$ , $U = 68,50$ , $z = -5,190$
V	74 (4,02)	87,61 (5,66)	$P < 0.001$ , $U = 55,00$ , $z = -5,416$

Following, we describe the specimens clustering in OTU2 as the new species:

***Uromastix yemenensis* sp. nov.**

**Holotype.** ZFMK 47861, adult male, Abyan Governate, vicinity of Lodar (Lawdar), Republic of Yemen, leg. I. Haikal, don. 1985.

Paratypes: ZFMK 47860, adult female, Abyan Governate, vicinity of Lodar (Lawdar), Republic of Yemen, leg. I. Haikal, don. 1985. ZFMK 49036, adult male, Abyan Governate, vicinity of Lodar (Lawdar), Republic of Yemen, leg. I. Haikal, don. 1985. MTD 29475, adult male, Abyan vicinity of Zingibar (Zinjibar), Republic of Yemen, coll. M.A. Hussein, leg. Dr. W. Wranik, don. 22.X.1987.

**Diagnosis.** *Uromastix yemenensis* sp. nov. is a medium-sized member of the *U. ocellata* group, which is distinguished from the more primitive *U. asmussi*, *U. loricata* and *U. hardwickii* by the absence of intercalary scales between the whorls of the dorsal surface of its tail; from *U. thomasi* and *U. princeps* by the longer tail and from all other species of the genus (with the exception of *U. ocellata*, *U. ornata*, *U. benti* and *U. macfadyeni*) by the arrangement of the whorls of the tail. In *U. yemenensis* as well as in the four above mentioned species the last 8–21 whorls each consists of a simple continuous series of large scales, while in all other *Uromastix* species only the last 2–5 whorls are like this.

The new species differs from *U. ocellata*, *U. ornata* and *U. macfadyeni* in lacking femoral- and preanal pores. *Uromastix yemenensis* differs from its sister species *U. benti* in having smaller and more scales around midbody (192.53 +/-16.63 in *U. yemenensis* vs. 160.05 +/- 8.98 in *U. benti*) and smaller and more ventrals (87.61 +/-5.66 in *U. yemenensis* vs. 74 +/-4.02 in *U. benti*).

**Description of the holotype.** Snout-vent-length: 16.5 cm; tail length 13.3 cm; head length 32 mm; head width 28 mm; width of the tail between the 4<sup>th</sup> and 5<sup>th</sup> whorl: 18.5 mm; maximum tail width at the 5<sup>th</sup> whorl: 29 mm; 227 scales around midbody; 90 scale rows between gular- and inguinal fold, 36 gular scales counted from a line between the anterior margins of the ear openings to the mental scale; 24 (left) and 24 (right) scales between the mid of the ear openings under the jaws to the mental scale; On each side 5 scale rows between the supralabials and the enlarged suboculars; 37 scales around the 5<sup>th</sup> whorl, 25 tail whorls, the last 19 whorls are made up as single continuous scale rows; 15 subdigital lamellae beneath the 4<sup>th</sup> toe; no preanal/femoral pores, but more or less enlarged callose scales along the thighs in the position normally occupied by femoral/preanal pores. The holotype has a total length of 29.8 cm. The tail length is 80.61% of the SVL.

Head covered with irregularly arranged scales of different size; the smallest above the eyes. Occipital and neck scales small and smooth. Anterior margins of the ear openings covered with enlarged, triangular scales. Scales of the forelegs smooth, scales on the sole with a well developed median keel. Subdigital scales dis-

tinctly keeled; each subdigital scale with 6–8 keels. Gular scales and ventral scales smooth. Forelegs and back without enlarged tubercles.

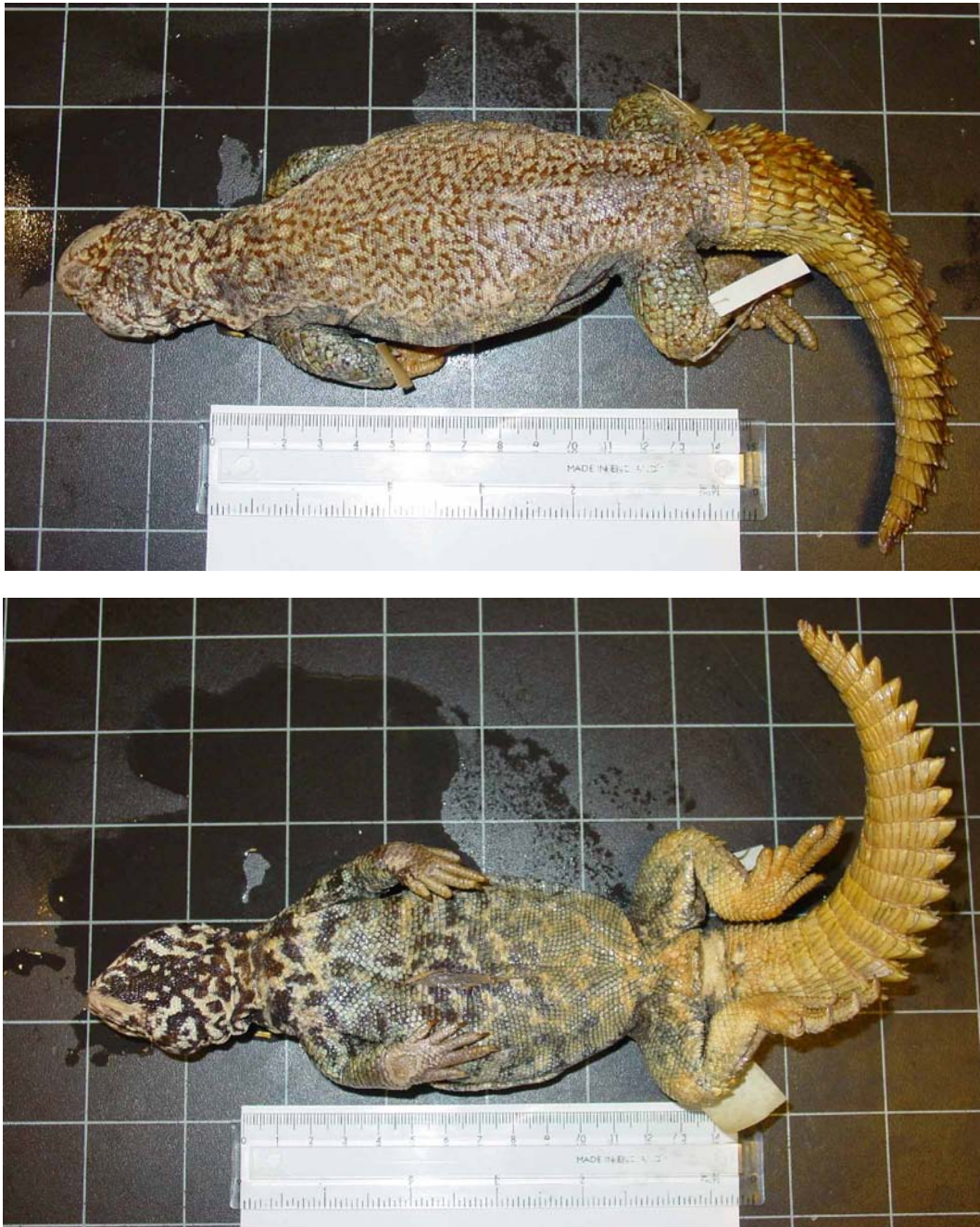

**PLATE 1.** Lectotype of *Uromastix benti* (BMNH 1946.8.11.72), dorsal & ventral view. Photos: C. McCarthy.

Thigh of the hind legs without enlarged tubercular scales; scales on the backside of the thigh distinctly smaller than on the front side. Ventral parts of the lower leg with smooth rhomboid scales, larger than the ventral scales. Dorsal parts with enlarged tubercular scales intermixed with very small smooth scales. Scales on the upper side of the feet slightly keeled and pointed. A row of enlarged triangular and pointed scales running from the base of the 4<sup>th</sup> toe to the ankle.

Scales on the dorsal side of the tail strongly keeled, with the median rows only slightly pointed while the marginal rows are strongly pointed.



**PLATE 2.** Paralectotype of *Uromastyx bentii* (BMNH 1946.8.11.68), dorsal & ventral view. This specimen is not conspecific with *U. bentii* but with the species described in the present paper. Photos: C. McCarthy.

**Colouration in preservative.** Ground colour of back, tail and hind legs yellowish brown. Tail without distinct pattern, hind legs with very small dark brown dots. Back with a pattern consisting of dark brown lines and dots; five distinct cross bands without or with very few pattern on the back. Dorsal side of the front legs anthracite coloured. Hands yellowish brown. Head yellowish brown, dark brown marbled. Underside of the head anthracite coloured with some yellowish brown dots. Ventral parts of forelegs and chest marbled with grey. Belly with narrow grey/anthracite crossbands.



**PLATE 3.** Holotype of *U. yemenensis* (ZFMK 47861), dorsal & ventral view. Photos: T. Wilms.

**Variation.** For measurements and scale counts of the type series of *U. yemenensis* see Table 7.

**TABLE 7.** Measurements (in mm) and scale counts of the type series of *U. y. yemenensis* and *U. y. shobraki*

Number	Species	Sex	SVL	TL	HW	HL	W	SD	TW	
ZFMK 47861	<i>U. yemenensis yemenensis</i>	Holotype	1.0	165	133	28.0	32.0	25	15	18.5
ZFMK 47860	<i>U. yemenensis yemenensis</i>	Paratype	0.1	163	138	28.0	35.0	26	15	19.0
ZFMK 49036	<i>U. yemenensis yemenensis</i>	Paratype	1.0	146	115	26.0	30.5	23	15	19.0
MTD 29475	<i>U. yemenensis yemenensis</i>	Paratype	1.0	139	116	24.0	28.0	26	18	16.0
ZFMK 48681	<i>U. yemenensis shobraki</i>	Holotype	1.0	161	150	33.0	32.0	27	17	21.0
ZFMK 48680	<i>U. yemenensis shobraki</i>	Paratype	1.0	177	defect	34.0	36.0	defect	16	20.5
MHNG 2496.55	<i>U. yemenensis shobraki</i>	Paratype	0.1	177	156	31.5	33.0	25	16	21.5
MHNG 2496.56	<i>U. yemenensis shobraki</i>	Paratype	1.0	122	115	24.0	25.0	26	15	15.0
MHNG 2553.56	<i>U. yemenensis shobraki</i>	Paratype	unknown	129	114	22.5	20.0	26	15	15.5
MHNG 2455.100	<i>U. yemenensis shobraki</i>	Paratype	0.1	160	141	30.5	33.5	24	17	20.0

continued.

Number	Species	TW max	G	MBS	V	SW	PP left	PP right	LS left	LS right
ZFMK 47861	<i>U. yemenensis yemenensis</i>	29.0	36	227	90	37	0	0	6	5
ZFMK 47860	<i>U. yemenensis yemenensis</i>	27.0	34	219	95	37	0	0	3	3
ZFMK 49036	<i>U. yemenensis yemenensis</i>	27.0	35	217	86	40	0	0	4	4
MTD 29475	<i>U. yemenensis yemenensis</i>	22.5	32	208	93	39	0	0	6	5
ZFMK 48681	<i>U. yemenensis shobraki</i>	29.0	30	207	97	38	0	0	3	4
ZFMK 48680	<i>U. yemenensis shobraki</i>	28.0	29	163	84	36	0	0	3	3
MHNG 2496.55	<i>U. yemenensis shobraki</i>	31.0	27	180	88	32	0	0	4	3
MHNG 2496.56	<i>U. yemenensis shobraki</i>	20.0	28	187	79	32	0	0	3	4
MHNG 2553.56	<i>U. yemenensis shobraki</i>	20.0	25	181	85	39	0	0	3	4
MHNG 2455.100	<i>U. yemenensis shobraki</i>	29.0	33	198	91	32	0	0	5	4

continued.

Number	Species	SO left	SO right	HS left	HS right	ES	PES
ZFMK 47861	<i>U. yemenensis yemenensis</i>	5	5	24	24	13	8
ZFMK 47860	<i>U. yemenensis yemenensis</i>	6	5	27	25	13	8
ZFMK 49036	<i>U. yemenensis yemenensis</i>	5	6	28	28	13	7
MTD 29475	<i>U. yemenensis yemenensis</i>	4	4	24	24	13	6
ZFMK 48681	<i>U. yemenensis shobraki</i>	4	4	28	27	13	9
ZFMK 48680	<i>U. yemenensis shobraki</i>	4	4	27	25	10	8
MHNG 2496.55	<i>U. yemenensis shobraki</i>	4	4	26	25	11	10
MHNG 2496.56	<i>U. yemenensis shobraki</i>	3	4	25	23	10	8
MHNG 2553.56	<i>U. yemenensis shobraki</i>	4	4	25	27	12	10
MHNG 2455.100	<i>U. yemenensis shobraki</i>	5	5	31	29	14	8

The two male paratypes (ZFMK 49036, MTD 34675) are in a good accordance to the holotype in respect to overall appearance and colouration. The only female present in the type series (ZFMK 47860) is much paler in colouration. The ground colour of this specimen is a yellowish brown with a pattern of small dark brown lines and dots. Five pale cross bands are present on the animals back. The ventral side of the specimen is almost entirely lacking any pattern (only some very small dots on the underside of the head are visible). The ground colour of the ventral is a light yellowish brown.

**Etymology.** The name refers to the known distribution area.

The western populations of *U. yemenensis* differ genetically and are constantly distinct in respect to their colour pattern and are therefore described as:

***Uromastyx yemenensis shobraki* ssp. nov.**

**Holotype.** ZFMK 48681, adult male, Mafraq Mocca (Mafraq al-Mukha), km 13.5, Republic of Yemen, leg. B. Schätti, 5.–6.IV.1988.

Paratypes: ZFMK 48680, adult male, Mafraq Mocca (Mafraq al-Mukha), km 13.5, Republic of Yemen, leg. B. Schätti, 5.–6.IV.1988. MHNG 2496.55, adult female, Tihama, between Mocca (al-Mukha) and Oued Zabid, Republic of Yemen, coll. P. A. Panchaud, leg. M. Guillod, V.1990. MHNG 2496.56, male, Tihama, between Mocca (al-Mukha) and Oued. Zabid, Republic of Yemen, coll. P. A. Panchaud, leg. M. Guillod, V.1990. MHNG 2553.56, semiadult, Mafraq al-Mukha, km 1.5, Republic of Yemen, leg. B. Schätti, 05.IV.1994. MHNG 2455.100, adult female, Mafraq al-Mukha, km 13.5, Republic of Yemen, leg. B. Schätti,



19.VI.1989.

**Diagnosis.** *Uromastyx yemenensis shobraki* shows the distinctive features listed in the diagnosis of the nominate subspecies, *U. y. yemenensis*. It differs from *U. bentii* in having smaller scales around midbody (189.68 +/- 12.84 in *U. yemenensis shobraki* vs. 160.05 +/- 8.98 in *U. bentii*) and smaller ventrals (86.91 +/- 5.13 in *U. y. shobraki* vs. 74 +/- 4.02 in *U. bentii*). *Uromastyx y. shobraki* is differentiated from *U. y. yemenensis* not only by its larger maximum size [39.3 cm in *U. y. shobraki* (MHNG 2538.47) vs. 33.2 cm in *U. y. yemenensis* (BMNH 1946.8.11.68)] but also in different colour pattern (see Plate 5) and in significant genetic differences (Tab. 5).

**Description of the holotype.** Snout-vent-length: 16.1 cm; tail length 15 cm; head length 32 mm; head width 33 mm; width of the tail between the 4<sup>th</sup> and 5<sup>th</sup> whorl: 21 mm; maximum tail width at the 5<sup>th</sup> whorl: 29 mm; 207 scales around midbody; 97 scale rows between gular- and inguinal fold, 30 gular scales counted from a line between the anterior margins of the ear openings to the mental scale; 28 (left) and 27 (right) scales between the mid of the ear openings under the jaws to the mental scale; On each side 4 scale rows between the supralabials and the enlarged suboculars; 38 scales around the 5<sup>th</sup> whorl, 27 tail whorls, the last 21 whorls are made up as single continuous scale rows; 17 subdigital lamellae beneath the 4<sup>th</sup> toe; no preanal/femoral pores, but more or less enlarged callose scales along the thighs in the position normally occupied by femoral/preanal pores. The holotype has a total length of 31.1 cm. The tail length is 93.17% of the SVL.

Head covered with irregularly arranged scales of different size; the smallest above the eyes. Occipital and neck scales small and smooth. Anterior margins of the ear openings not covered with enlarged scales. Scales of the forelegs smooth, scales on the sole with a well developed median keel. Subdigital scales only slightly keeled. Gular scales and ventral scales smooth. Forelegs and back without enlarged tubercles.

Thigh without enlarged tubercular scales; scales on the backside of the thigh distinctly smaller than those on the front. Ventral surface of the lower leg with smooth rhomboid scales, larger than the ventral scales. Dorsal surface with enlarged tubercular scales intermixed with very small smooth scales. Scales on the upper side of the feet slightly keeled and pointed. A patch of enlarged triangular and pointed scales present between the base of the 4<sup>th</sup> and 5<sup>th</sup> toe to the ankle.

Scales on the dorsal side of the tail, strongly keeled, with the median rows only slightly pointed while the marginal rows are strongly pointed.

**Colouration in preservative.** Dorsal surface of head, body and hind limbs dark brown, tail somewhat lighter. Light brown roundish dots (diameter 4–5 scales) are present on the dorsum, tending to form transverse rows. In addition, irregular light brown dots are present on the whole dorsum. Colouration of the hands not different from the colouration of the forearm. Head dark brown, with light brown pattern. Ventral side of the specimen yellowish brown. Ventral side of head and chest marbled with anthracite and dark brown. On the sides of the belly exists an anthracite-coloured stripe-like pattern.

**Variation.** For measurements and scale counts of the type series of *U. y. shobraki* see Table 7.

**Etymology.** This taxon is named in honour of Dr. Mohammed Shobrak, Director of the “National Wildlife Research Centre, NWRC” in Taif, Saudi Arabia, for his outstanding achievements regarding the conservation of Arabian Wildlife.

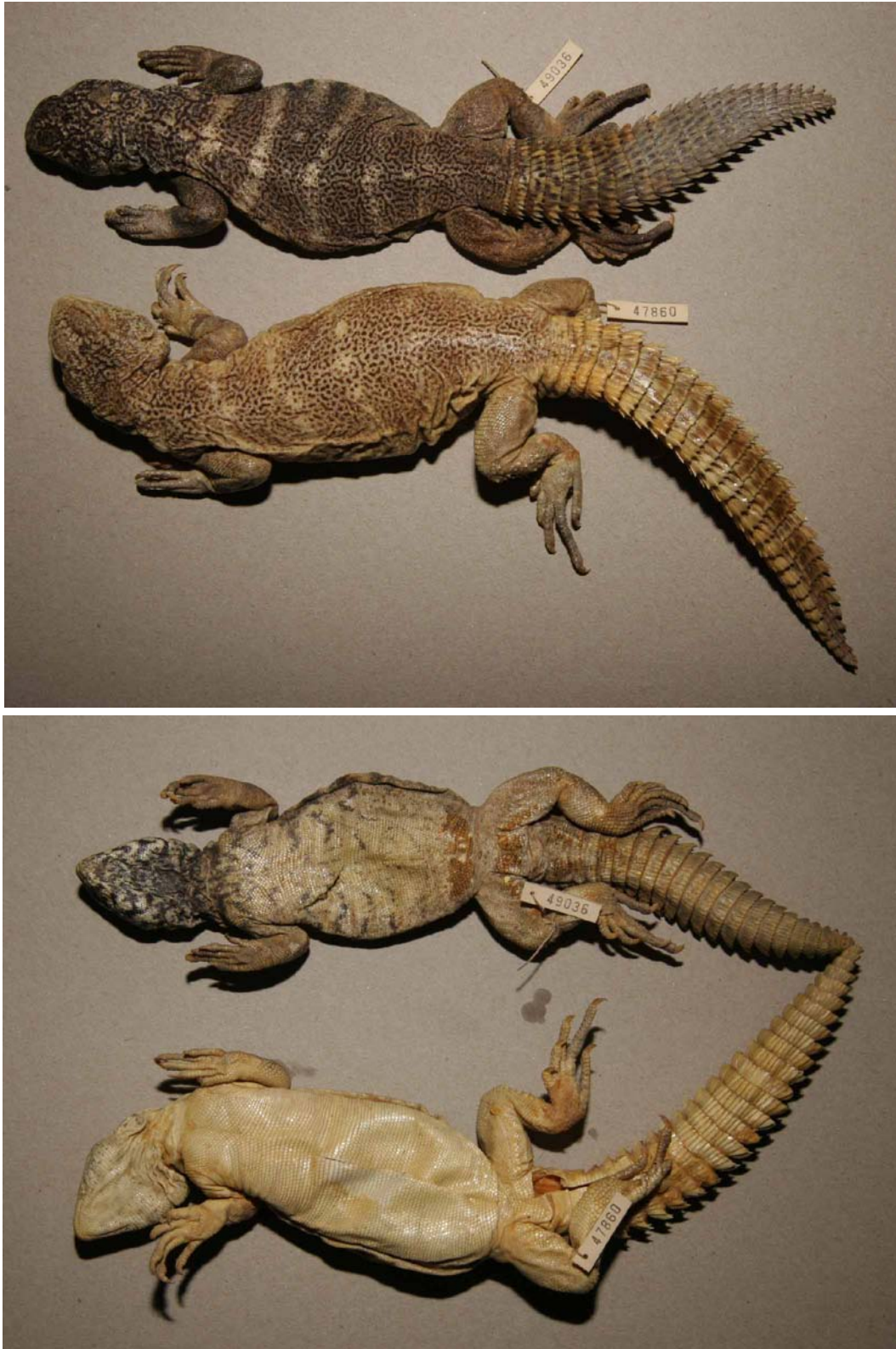

**PLATE 4.** Dorsal & ventral view of ZFMK 47860 and ZFMK 49036 (Paratypes of *U. yemenensis*) Photos: T. Wilms.

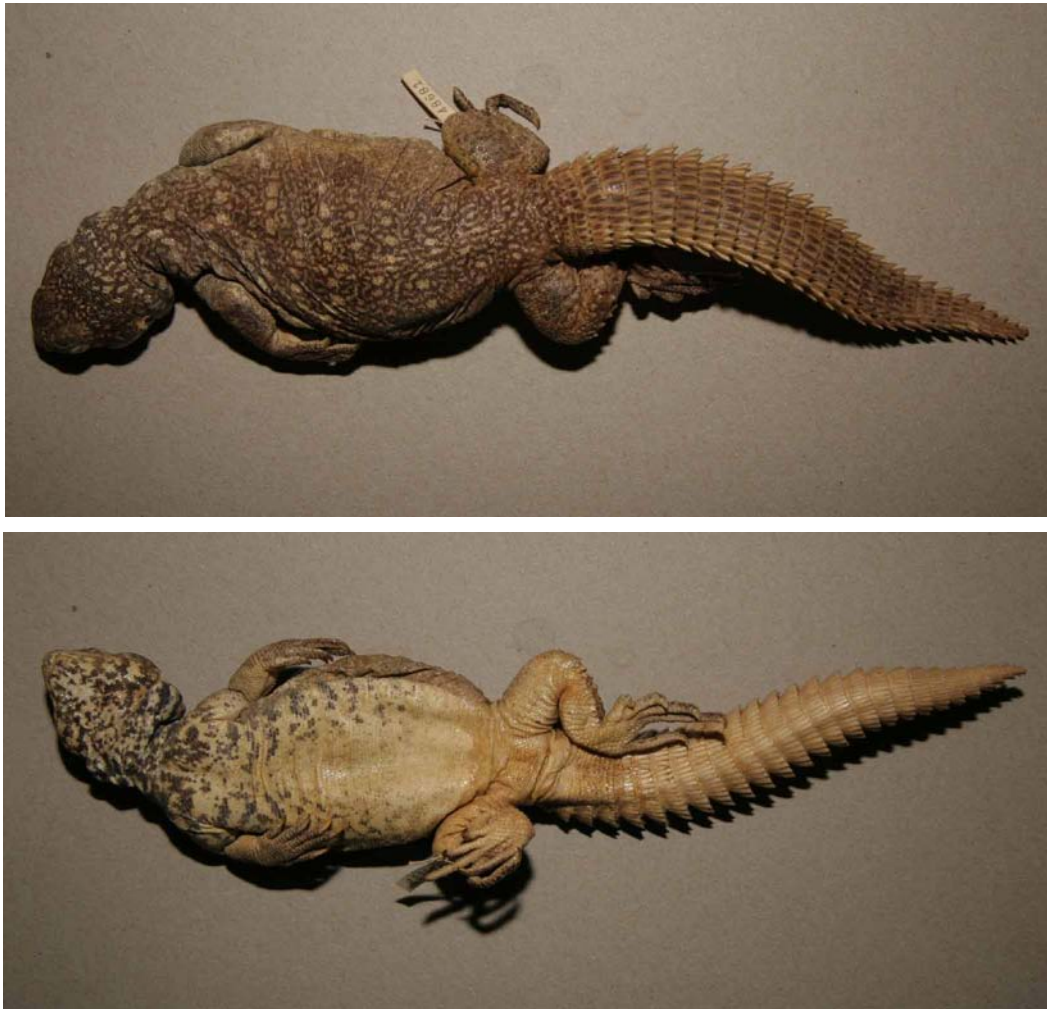

PLATE 5. Holotype of *U. yemenensis shobraki* (ZFMK 48681), dorsal & ventral view. Photos: T. Wilms.

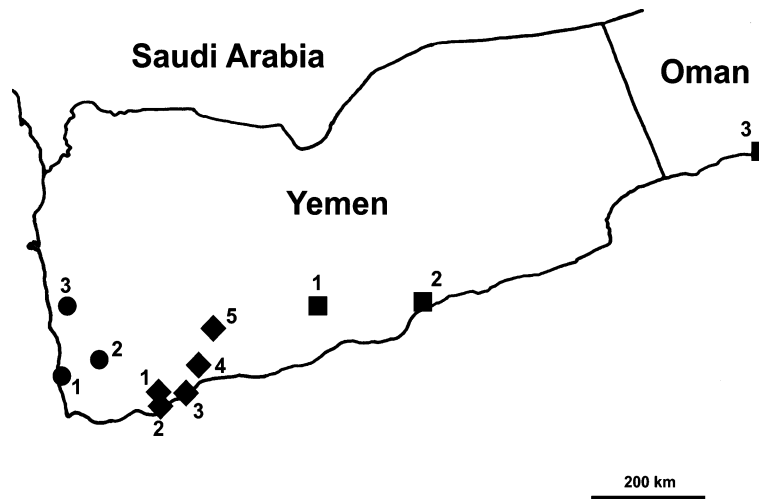

FIGURE 4. Distribution of *Uromastix yemenensis*. *U. y. shobraki* ●: 1 Al-Mukha; 2 Taizz; 3 Zabid. *U. y. yemenensis* ◆: 1 Lahij; 2 50 mls of Aden; 3 Zinjibar; 4 Abian-Area / Abian-Mountains; 5 Lawdar. *U. benti* ■: 1 Azzan; 2 Al-Mukalla; 3 Vicinity of Mirbat (Oman).

**Distribution.** *Uromastix yemenensis* is distributed in the south-western parts of the Republic of Yemen, with the range extending from the vicinity of Lawdar west to the Red Sea and from Zabid south to the Gulf of Aden. For the distribution areas of the subspecies of *U. yemenensis* see Fig. 4. The areas of both subspecies

are separated by a series of mountains and mountain ranges (example: Jebel Manar, Jebel Sawraq, Jebel Sabir, Jebel Dawran) with heights up to 3200 m.

## Acknowledgements

We would like to thank H.E. Prof. Dr. A.H. Abuzinada, former Secretary General, National Commission for Wildlife Conservation and Development (NCWCD), Riyadh, Saudi Arabia; Dr. Mohammed Shobrak, NCWCD, Prof. Dr. I. A. Nader, NCWCD; Dr. H. Tatwani, NCWCD; Mr. Ali bin Amer al Kiyumi, Director-General of Nature Reserves, Muscat, Oman and Mr. S. M. Al-Saady, Director of Research, Muscat, Oman, for their hospitality and help during the field works of T. Wilms and for issuing the permits required. Special thanks are due to Felix Hulbert, Eltville, Germany for his companionship in the field.

Special thanks are due to Prof. Dr. Wolfgang Böhme (Zoologisches Forschungsmuseum A. Koenig, Bonn, ZFMK) for his support and for the many fruitful discussions on *Uromastyx* taxonomy.

We are grateful to the curators of the following museums for their hospitality and/or for the loan of important collections: Dr. E. N. Arnold, Dr. C. McCarthy and Dr. B. Clarke, The Natural History Museum, London, UK; Dr. F. Tiedemann, Naturhistorisches Museum Wien, Vienna, Austria; Dr. M. Poggesi and Dr. C. Corti, Museo Zoologico de „La Specola“, Florence, Italy; Dr. V. Mahnert, Dr. J. Mariaux, Museum d’histoire naturelle, Geneva, Switzerland; Dr. I. Ineich, Muséum National d’histoire naturelle, Paris, France; Prof. F.J. Obst and Dr. U. Fritz, Museum für Tierkunde, Dresden, Germany; Dr. K. Klemmer and Dr. G. Köhler, Forschungsinstitut und Naturmuseum Senckenberg, Frankfurt a.M., Germany; Dr. J. Hallermann, Zoologisches Institut und Zoologisches Museum der Universität Hamburg, Germany; Dr. R. Günther, Museum für Naturkunde, Humboldt-Universität, Berlin, Germany; Dr. U. Gruber and Dr. F. Glaw, Zoologische Staatssammlung München, Germany. Dr. C. McCarthy, (BMNH, London) provided photographs of some specimens under his care, and Philipp Wagner (ZFMK, Bonn) photographed the syntypes of *U. simonyi*. Thomas Wilms is especially grateful to his brother, Matthias Wilms, who shared his knowledge on computers and mathematical science and to the Wünstel family (Reptilium Landau) for providing financial resources..

## References

- Amer, S.A.M. & Kumazawa, Y. (2005) Mitochondrial DNA sequences of the Afro-Arabian spiny-tailed lizards (genus *Uromastyx*; family Agamidae): phylogenetic analyses and evolution of gene arrangements. *Biological Journal of the Linnean Society*, 85, 247–260.
- Anderson, J. (1894) On two new Species of Agamoid Lizards from the Hadramut, South-eastern Arabia. *The Annals and Magazine of Natural History*, (6) 14, 376–378
- Anderson, J. (1896) *A Contribution to the Herpetology of Arabia with a Preliminary List of the Reptiles and Batrachians of Egypt*. R.H. Porter London, 122 pp.
- Arnold, E.N. (1986) A Key and Annotated Check List to the Lizards and Amphibaenians of Arabia. *Fauna of Saudi Arabia* 8, 385–435.
- Bell, T. (1825) Description of a new species of Lizard. *Zoological Journal London*, 1, 457–460.
- Blanford, W.T. (1874) Description of two Uromasticine Lizards from Mesopotamia and Southern Persia. *Proceedings of the Zoological Society of London*, 1874, 656–661.
- Forskål , P. (1775) *Descriptiones animalium, avium, amphibiorum, piscium, insectorum, vermium; quae in itinere Orientali observavit Petrus Forskal. Post mortem auctoris edidit C. Niebuhr, adjuncta est materia medica Kahirina atque tabula Maris Rubris geographica*. Heineck et Faber, Havniae (Copenhagen), S. 20+xxxiv+164.
- Hall, T.A. (1999) BioEdit: a user-friendly biological sequence alignment editor and analysis program for Windows 95/98/NT. *Nucleic Acids Symposium Series*, 41 : 95–98.
- Handl, A. (2002) *Multivariate Analysemethoden*. Springer-Verlag, 463 pp.
- Hardwicke, J. & Gray, J.E. (1827) A Synopsis of the Species of Saurian Reptiles, collected in India by Major-General Hardwicke. *Zoological Journal London*, 3, 213–229.

- Heyden, C.H.G. von (1827) Reptilien. In: Rüppel, E. (Ed.), Atlas zu der Reise im nördlichen Afrika. Frankfurt a. M.
- Huelsenbeck, J.P. & Ronquist, F. (2001) MRBAYES: Bayesian inference of phylogenetic trees. *Bioinformatics*, 17, 754–755.
- Jardine, N. & Sibson, R. (1968) The construction of hierarchic and non-hierarchic classifications. *The Computer Journal*, 11, 177.
- Lichtenstein, H. (1823) *Verzeichnis der Doubletten des Zoologischen Museum der Königlichen Universität zu Berlin nebst Beschreibung vieler bisher unbekannter Arten von Säugetieren, Vögeln, Amphibien und Fischen*. Trautwein, Berlin, X+118 pp.
- Mateo, J., Geniez, P., López-Jurado, L. & Bons, J. (1998) Chorological analysis and morphological variations of Saurians of the genus *Uromastix* (Reptilia, Agamidae) in western Sahara. Description of two new taxa. *Rev. Esp. Herp.*, Madrid, (1998)12, 97–109.
- Moody, S.M. (1987) A preliminary cladistic study of the lizard genus *Uromastix* (Agamidae, sensu lato), with a checklist and diagnostic key to the species. *Proceedings of the Fourth Ordinary General Meeting of the Society of European Herpetology*, Nijmegen, Holland, pp. 285–288.
- Müller, L. (1922) Über eine neue *Uromastix*-Art aus der Zentral-Sahara. *Naturwissenschaftlicher Beobachter*, 63, 193–201.
- Nylander, J.A.A. (2002) MrModeltest 1.1b, Uppsala, Sweden.
- O'Shaughnessy, A.W.E. (1880) Description of a new Species of *Uromastix*. *Proceedings of the Zoological Society of London*, 1880, 445–446.
- Palumbi, S.R., Martin, A., Romano, S., McMillan, W.O., Stice, L. & Grabowski, G. (1991) *The simple fool's guide to PCR*. Department of Zoology and Kewalo Marine Laboratory, Hawaii, 47 pp.
- Parker, H.W. (1930) Three new Reptiles from Southern Arabia. *The Annals and Magazine of Natural History*, 6 (Ser. 10), 594–598.
- Parker, H.W. (1932) Two Collections of Reptiles and Amphibians from British Somaliland. *Proceedings of the Zoological Society of London*, 1932, 335–367.
- R Development Core Team (2005) R: A language and environment for statistical computing. *R Foundation for Statistical Computing*, Vienna, Austria. ISBN 3-900051-07-0, URL <http://www.R-project.org>.
- Rastegar-Pouyani, N. (2005) A multivariate analysis of geographic variation in the *Trapelus agilis* complex (Sauria: Agamidae). *Amphibia-Reptilia*, 26 (2005), 159–173.
- Reeder, T.W. (2003) A phylogeny of the Australian *Sphenomorphus* group (Scincidae: Squamata) and the phylogenetic placement of the crocodile skinks (*Tribolonotus*): Bayesian approaches to assessing congruence and obtaining confidence in maximum likelihood inferred relationships. *Molecular Phylogenetics and Evolution*, 27, 384–397.
- Schmitz, A. (2003) *Taxonomic and phylogenetic studies on scincid lizards (Reptilia: Scincidae)*. Unpubl. PhD thesis. University of Bonn, 262 pp.
- Steindachner, F. (1899) Sitzung der mathematisch-naturwissenschaftlichen Classe vom 20. April 1899. *Anzeiger der Kaiserlichen Akademie der Wissenschaften, mathematisch-naturwissenschaftliche Classe*, 36 (12), 143–144.
- Strauch, A. (1863) Charakteristik zweier neuen Eidechsen aus Persien. *Bulletin of the Academy of Sciences*, St. Petersburg, 6, 477–480.
- Swofford, D.L. (2002) PAUP\*. Phylogenetic Analysis Using Parsimony (\*and Other Methods). Version 4.0b10. Sinauer Associates, Sunderland, Massachusetts, USA.
- Thompson, J.D., Gibson, T.J., Plewniak, F., Jeanmougin F. & Higgins, D.G. (1997) The ClustalX windows interface: flexible strategies for multiple sequence alignment aided by quality analysis tools. *Nucleic Acids Research*, 24, 4876–4882.
- Walsh, P.S., Metzger, D.A. & Higuchi, R. (1991) Chelex 100 as a medium for simple extraction of DNA for PCR-based typing from forensic material. *BioTechniques*, 10(4), 506–513.
- Wilms, T. (2001) *Dornschwanzagamen – Lebensweise, Pflege, Zucht*. Herpeton Offenbach, 144 pp.
- Wilms, T. (2005) *Uromastix – Natural History, Captive Care, Breeding*. Herpeton Offenbach, 143 pp.
- Wilms, T. & Böhme, W. (2000a) Revision der *Uromastix-acanthinura*-Artengruppe, mit Beschreibung einer neuen Art aus der Zentralsahara (Reptilia: Sauria: Agamidae). *Zoologische Abhandlungen des Staatlichen Museums für Tierkunde Dresden*, 51 (8), 73–104.
- Wilms, T. & Böhme, W. (2000b) A new species of the genus *Uromastix* (Sauria: Agamidae: Leiolepidinae) from South-eastern Arabia, with comments on the taxonomy of *Uromastix aegyptia* (Forskål 1775). *Herpetozoa*, 13 (3/4), 133–148.
- Wilms, T. & Böhme, W. (2000c) Zur Taxonomie und Verbreitung der Arten der *Uromastix-ocellata*-Gruppe (Sauria: Agamidae). *Zoology in the Middle East*, 21, 55–76.
- Wilms, T. & Böhme, W. (in press) A review of the taxonomy of the spiny-tailed lizards of Arabia (Reptilia: Agamidae: Leiolepidinae: *Uromastix*), with new data on *Uromastix leptieni* WILMS & BÖHME, 2000. *Fauna of Arabia*
- Yang, Z. H., Goldman, N. & Friday, A. (1994) Comparison of Models for Nucleotide Substitution Used in Maximum-Likelihood Phylogenetic Estimation. *Molecular Biology and Evolution*, 11, 316–324.

**Appendix A. Material examined (excluding specimens that have only be used as DNA vouchers; see Table 1)**

*Uromastyx benti*

Makulla, Yemen: NMW 16174; NMW 21213:2–9; MTD 24589; ZMH R04513; MHNP 1895.43, Paralectotype; BMNH 1946.8.11.69–71, Paralectotypes; BMNH 1946.8.11.72, Lectotype.  
Assan, Yemen: NMW 21214:1–2, Syntypes *U. simonyi*.  
Wadi Abr/ Hadramaut, Yemen: BMNH 1956.1.7.26  
Hadramaut, Yemen: BMNH 1953.1.8.52  
Mirbat, Sultanate of Oman: ZFMK 73680–81; ZFMK 83347; ZFMK 83801

*Uromastyx yemenensis yemenensis*

Lawdar, Abyan-Gouvernement, Yemen: ZFMK 47861, Holotype; MTD 26951; MTD 26952; MTD 28873; ZFMK 47860, Paratype; ZFMK 49036, Paratype;  
Zingibar, Abyan-Gouvernement, Yemen: MTD 24554; MTD 29475, Paratype.  
Lahej, Abyan-Gouvernement, Yemen: MTD 24555  
Hills 50 mls from Aden, Yemen: BMNH 95.11.27.6–7  
Yabian mountains, Yemen: BMNH 99.12.13.51  
Amran/Aden, Yemen: MTD 25441  
Wadi Tiban west of Aden, Yemen: BMNH 1963.755  
between Mount Manif and Jimil/N. of Lahej, Yemen: BMNH 99.12.13.106  
Abyan-Gebiet (Abyan-Gouvernement), Yemen: MTD 34675  
Makulla, Yemen (doubtful record): BMNH 1946.8.11.68, Paralectotype *U. benti*

*Uromastyx yemenensis shobraki*

Northern Yemen: MTD 31624; MTD 32847; MTD 31624; MTD 32847; ZFMK 55651–52; ZFMK 58047; ZFMK 60687; ZFMK 73677  
Mafraq-Al Mukha, Yemen: MHNG 2455.100, Paratype; MHNG 2464.44; MHNG 2553.56, Paratype; ZFMK 48680, Paratype; ZFMK 48681, Holotype; MZUF 33614–15; BMNH 1988.54–55;  
Oued Zabid, Yemen: MHNG 2538.47; MHNG 2542.13–14; MHNG 2527.92  
Between Al-Mukha and Oued Zabid: MHNG 2496.55–56, Paratypes  
Taizz, Tihama, Yemen: BMNH 1987.854  
Southern Hejaz (Country not reliably traceable): BMNH 1938.2.1.47

*Uromastyx macfadyeni*

SE Dagah Shabell, 24 mls SE Berbera, Somalia: BMNH 1946.8.14.52, Paratype  
Heis 20 mls W Mait, Somalia: BMNH 1956.1.6.55  
Berbera, Somalia: BMNH 1946.8.14.54, Holotype

*Uromastyx ocellata*

Egypt: MHNP 1897.348–49  
Oasis Harar: NMW 21215  
Dongola Province, Sudan: ZSM 219/1976  
Merowe/ Dongola, Sudan: BMNH 1927.8.13.38–39  
Sinkat, Sudan: BMNH 1914.5.14.13  
Suakim, Sudan: NMW 21216; BMNH 97.10.28.202–9; ZFMK 20822  
40 km W Suakim direction Sinkat: ZFMK 38396  
Tehamiyam, Sudan: BMNH 1953.17.63–65

Nubia (no exact locality): ZMB 811 Holotype

Algena, Eritrea: BMNH 1959.1.5.6–10

Borama District, Somalia: BMNH 1937.12.5.130; BMNH 1937.12.5.117–19; BMNH 1937.12.5.121–25, BMNH 1937.12.5.127–28;

Reg. d'Ali, Djibouti: MHNP 1996.231

Djibouti: MHNG 2394.100

### *Uromastyx ornata ornata*

Mohila (=Al Muwaylih), Saudi Arabia: SMF 10403 Holotype

Tor, Egypt: NMW 21220; BMNH 97.10.28.199

Dahab, Egypt: NMW 21217

Sherm Scheikh, Egypt: NMW 21219:1–4

Egypt: MHNP 6970; MHNP 6954; ZFMK 65607; ZFMK 65609

Mount Sinai, Egypt: MHNP 1909.176–77

Sinai Peninsula, Egypt: ZMH R 04525–26

Oued Feiran, Egypt: ZFMK 65174–75

Elath, Israel: ZFMK 8576

### *Uromastyx ornata philbyi*

Jabal as Sinfra, Saudi Arabia: BMNH 1980.55

Oued Sawawin, Saudi Arabia: MHNG 2457.35

Jebel Hababa, Saudi Arabia: MHNG 2457.33–34

Mecca bypass km 56, Saudi Arabia: MHNG 2536.49

Mecca bypass km 91, Saudi Arabia: BMNH 1985.882

Burayman, Saudi Arabia: BMNH 1964.296; BMNH 1979.960; BMNH 1975.519

Jeddah, Saudi Arabia: MHNP 4318; BMNH 1986.436

21°14'N39°55'E, Saudi Arabia: BMNH 1986.434

Bazzah, Saudi Arabia: BMNH 1975.518

Oued Fatimah, Saudi Arabia: BMNH 1976.1748

21°15,5'N 39°55'E, Saudi Arabia: BMNH 1985.884

between Mecca and Shabwa, Saudi Arabia and Yemen: BMNH 1946.8.11.62–66, Paratypes; BMNH 1946.8.11.60, Holotype;

Ju Amlah 26 km NW Sa'dah, Yemen: MZUF 28187; MZUF 27906; MZUF 27884–85;